

# Pro'sKit®



## MT-8006B Data Diver



**User's Manual**

1<sup>st</sup> Edition' 2013





©2013 Prokit's Industries Co., Ltd.

## Safety Information

### Read First Before Use

Table 1 describes the international electrical symbols used on the tester and in this manual.

**Table 1. International Electrical Symbols**

	Warning: Risk of personal injury. See explanations in the manual. Caution: Risk of damage or destruction to equipment or software. See explanations in the manual.
	Warning: Risk of electric shock.
	Please keep an eye on the status or function of the equipment while operating.
	This equipment is not for connection to public communications networks, such as active telephone systems.



### Warning

- Never use MT-8006B on circuits of more than 100V.
- Never use MT-8006B or test leads if they are damaged. Inspect the case and test leads for damage before use.
- Disconnect unused test leads and connectors from the MT-8006B when testing telephone circuits.
- Never open the case except to change the battery or the fuse; no user-serviceable parts are inside.
- Disconnect all test leads before replacing the battery.
- Use only 1.5V AAA batteries, properly installed in the case, to power MT-8006B.
- If this equipment is used in a manner not specified by the manufacturer, the protection provided by the equipment may be impaired.

The following IEC symbols are used either on the Data Diver or throughout the manual:



**See Manual for details**



**Earth Ground**



**Conformité Européenne**

## **Standard package:**

- MT-8006B \* 1
- Headphone \* 1
- Angled bed of nails \* 1
- User Manual \* 1

## **DESCRIPTION**

MT-8006B Data Diver is a portable TEL test set used by installers, repair technicians and other authorized personnel for temporary communication and for servicing and installing analog voice telephones.

## **Design Features**

The MT-8006B provides a wide range of features for working on analog voice lines, and, in addition, it is equipped with protection features to prevent the accidental disruption of data services. Never use MT-8006B on circuits of more than 100V.

## **The following is a list of the MT-8006B features:**

- ◆ LCD display for dialing number, Caller ID, Clock and other information
- ◆ Indicator for determining the line service
- ◆ Headset & Angled bed of nails
- ◆ Smart power saving enables battery life up to 6 months
- ◆ 12 phone number memory for speed dialing, each memory up to 16 digits
- ◆ 16 dialing number memories each number up to 16 digits
- ◆ Support 2 dialing mode: Tone (DTMF) and pulse
- ◆ Up to 32 digits phone number memory for speed dialing key
- ◆ Pre-dialing and last number redial function
- ◆ PBX pause key, insert a PBX pause in stored numbers
- ◆ Telephone line polarity indicators
- ◆ Low battery indication
- ◆ Backlight function for easy reading even in dark areas
- ◆ RJ-11 port for changing test leads
- ◆ Ringer and voltage LED indication

**! WARNING:**

- ◆ The MT-8006B Data Diver is not designed to meet outside plant requirements. It is recommended that this product not be used outside during adverse and/or wet weather conditions.
- ◆ Legal requirements may exist regarding permission to connect equipment to a Telecom network operated by a public network operator.

**! CAUTION:**

The operator of this instrument is advised that if the equipment is used in a manner not specified in this manual, the protection provided by the equipment may be impaired.

**Physical Characteristics**

1. Phone strap hole
2. Speaker
3. Polarity indicator
4. Ringer and voltage LED indicator
5. Test mode switch
6. LCD Display
7. Headset Jack
8. Mute indicator
9. LO BATT indicator
10. Mute switch
11. Pulse/Tone switch
12. STO
13. PSE
14. LNR
15. RCL
16. ▼
17. DEL
18. OUT
19. ▲
20. Number pad 0~9, \*, #
21. Microphone
22. RJ-11 Jack

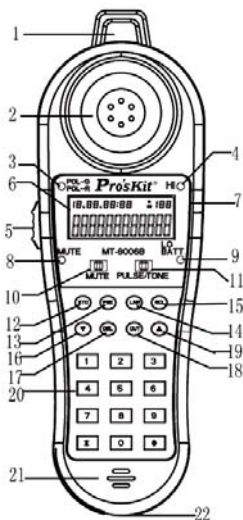

## LCD Display :

1. Mute indicator
2. Year / Phone number
3. Month
4. Polarity indicator:
  - red light : The red clip of Angled bed of nails is connect to the + line
  - green light : The red clip of Angled bed of nails is connect to the - line
5. Date
6. Hour
7. Minute
8. Incoming call indicator
9. Sequence of the call in list
10. Voltage LED indicator
  - When incoming call and ringing, the "HI" LED will flash
  - When voltage detected, the "HI" LED will lights up
11. Dialing call indicator
12. LO BATT indicator
13. Pulse/Tone switch
14. Mute switch

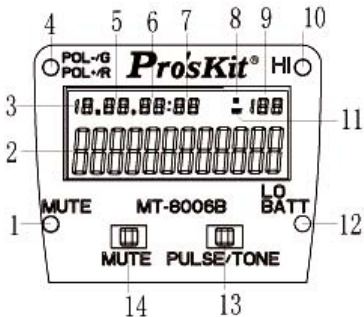

## Line cord connection

MT-8006B Data Diver is designed with a standard 6-position modular jack for quick connection of cord set. To place the cord set, simply remove the clip attachment screw, and put the terminal of strain relief over the boss behind the screw hole, then put the clip back and fasten the screw and plug the modular plug into the jack

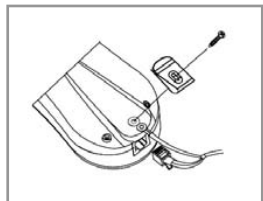

## ⚠ Caution:

In order to prolong the service lifetime of modular plug, please connect the strain relief terminal before plug into the modular jack

## Keys introduction

Key	Description	Function	
STO	Set and Storage  Direction	Press STO key will enter the setting mode, there are 12 setting screen on MT-8006B. Please refer to Operation section.	
▲/▼	key	Enter the incoming call list, scroll the numbers in call list and switch the setting screen.	
RCL	Recall	To initial a phone call from stored phone number	
DEL	Delete	Delete the number in list or erase the last digit from the input number	
LNR	Last number redial	Make a phone call for last dialing number or per-dial number	
PSE	Pause	Insert a PBX pause into the input number	
OUT	Call out list	Enter the dialing out number list	
*, #, 0~9	Number keys	Standard Phone number keys	

### Test mode switch

The test mode switch is a slide switch located on the left side of MT-8006B. Switch the test mode switch to the “Talk” position to make the Data Diver work as a telephone line tester. Switch the test mode switch to the “OFF” position for storage; switch the test mode switch to the “Mon” position to enable monitoring the line without disrupting it.

## Hand-free function

The MT-8006B Data Diver comes with a headset and a phone strap necklace. Connecting them to the headset jack and phone strap hole will give the MT-8006B a hands-free talk function. Please find the phone strap hole and the 2.5 mm jack on the right upper corner of the MT-8006B Data Diver.

## OPERATION

1. Remove the battery case lid and install 4pcs 1.5V AAA batteries in the battery compartment paying close attention to polarity of battery.

### 2. Parameter Setting

With the MT-8006B in the OFF position; pressing the STO key will enter the setting mode. The "SET 1 DATE" shows on LCD. User can switch the setting item by pressing the ▲/▼ key then press the STO key to enter the set item for detail setting. If user wants to change the setting press the ▲/▼ key again. When the correct setting appears press STO key to move to next setting. In the duration of setting press DEL will quit from the setting mode.

### ● **Date and time**

If the "SET 1 DATE" is displayed on LCD, press STO key to enter the Date and time setting. The number of year will flash, press ▲/▼ key to adjust the value of year. Pressing the STO key again will move to the month setting. Use the same method to change the value of month then press STO to move to the date and time setting. When all the values of date and time are settle down then press STO key to move to "SET 2 ACODE".

### ● **Area code**

When the "SET 2 ACODE" is show on LCD, press STO key to enter the area code setting item. LCD will show "ACODE-----". The first digit of area code will flash, press ▲/▼ key to change the value. Press STO key to move to the next digit. If all the digits are set, press STO key to enter "SET 3 FLASH".

### ● **Pause Duration**

If the "SET 3 FLASH" is displayed on LCD, press STO key to

enter the Pause Duration setting. LCD will show “FLASH 3 110”. It means the default pause duration time is 110 ms, Change the value by ▲/▼ keys then press STO to move to the “SET 4 LCD”.

- **LCD light adjust**

When the “SET 4 LCD” is displayed on LCD, press STO key to enter the LCD light adjust mode. There are 5 LCD light level can be selected. Press ▲/▼ key to change the level then press STO to jump to “SET 5 ALAR” or press DEL to quit.

**! CAUTION:**

The “SET 5 ALAR” is not used by MT-8006B; we suggest users do not to change the value in “SET 5 ALAR” setting item. In this setting item press STO to jump to “SET 6 IPP” or press DEL to quit.

- **Dialing mode**

If the “SET 6 IPP” is displayed on LCD, press STO key to enter the dial mode setting. The IPP ON/OFF will show on LCD, use ▲/▼ key to swap between them. If “IPP OFF” is selected, the dialing mode is tone; otherwise, the dialing mode is pulse.

3. Connect the angled bed of nails (or RJ11 plug) to the telecom line

- **Talk / OFF / Mon.** → Test mode switch :

The Data Diver has three basic modes of operation: Talk mode, OFF mode and Monitor mode. Before using the MT-8006B, please set the Data Diver to proper mode; otherwise, it will remain in the OFF mode.

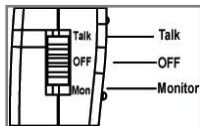

(Your Data Diver is set at the “OFF” position before your first use)

**Talk Mode:**

The “Talk” mode gives an off hook condition for dialing and talking as a common battery telephone. It is also available for memory dialing, last number dialing, caller dialing, redialing...etc.



## OFF Mode

- A. The “OFF” mode can be operated as either power off function or voltage inspection.
- B. Before testing the line, please slide the switch to the “OFF” position to detect if any voltage exists. When “HI” LED lights up, please disconnect from the tested line to avoid any damage to the Data Diver
- C. If the “HI” LED does not light up, then you can slide the switch to either “Talk” or “Mon” position for testing operation
- D. If the “HI” LED flashes and the ringer is ringing, it means there is an incoming call, slide the switch to “Talk” mode, then it can be used as a common telephone.
- E. For safety reason, please use the “OFF” mode to inspect the AC or DC voltage of unknown lines before testing

## Monitor mode

The “Mon” position removes the transmitter from the circuit and the “Mute” LED will light up automatically. It provides a high impedance coupling to allow line monitoring without disrupting conversations or signaling. If there is any signal present, there will be sound coming from the speaker



**When the Data Diver is in either “Talk” or “Mon” mode, the battery will supply power to the memory operation and Mute LED until it is drained. Please make sure the switch is in “OFF” position when not in use.**

### ● PULSE/TONE Switch

Use PULSE/TONE switch to change the dialing mode between pulse and tone (DTMF) mode

### ● STO →Store a number :

MT-8006B is in the OFF position or Talk position,  
Phone number + STO + N (N=0~9, \* , # )

### ● RCL →Recall (Dialing out a stored number) :

MT-8006B is on the Talk position,  
RCL + N (N=0~9, \* , # )

- **LNR** →Last Number Redial :  
 MT-8006B is on the Talk position,  
 If a call is not successful and you wish to redial the same number, just press the LNR button.  
 The last number redial function is available in either the Pulse or Tone Mode. The redial memory has a 32-digit capacity. When checking the incoming or dialing record, press the LNR button, the number you are dialing will show on the LCD
  
- **PSE** →Pause :  
 There are some cases where it may be necessary to insert a pause between digits of a stored number, such as when accessing a trunk through a PBX that requires a 9 to get out. To store a number with a pause, simply press the PSE button at the point where the pause is required. For example to store 9-555-1212. The PSE button inserts a 4 second pause.
  
- **DEL** →Delete :  
 In setting mode DEL key is used to quit setting mode. In pre-dial mode DEL key is used to delete the last digit. In call in/dialing out list, press DEL will delete a phone number and press DEL key for 4 seconds all the number in list will be erased.
  
- **MUTE** :  
 The mute switch turns the handset microphone and speakerphone microphone off for privacy in Talk mode. When turn the mute switch to left side, the "MUTE" LED lights up then the mute function is on, then turn to right side the "MUTE" LED will turns off and the mute function will also stop, and back to normal talk mode.
  
- **POL-/G ; POL+/R** →Telephone line polarity test :
  - Connect the telephone line to the Angled bed of nails.
  - MT-8006B is on the Talk position
  - If the LED is red light, the red Angled bed of nail is connected to the + line.
  - If the LED is green light, the red Angled bed of nail is connected to the - line.

- **LO BATT :**

If the LO BATT LED lights, that means the user needs to change the battery for fear of losing data.



- **Caution**

After the battery is removed, the memory of stored numbers will last for 15 seconds only. When changing the battery, please pay attention for the polarity of the battery. If the memory disappears, please follow the previous process as mentioned in this manual to store a number.

- **HI** →Line high voltage LED indication

1. Set the function switch to "OFF" position.
2. Connect the two test leads of the line to the angled bed of nails.
3. If the "HI" LED lights up; voltage over 70V was detected. Please don't connect the MT-8006B Data Diver to this line to avoid the Data Diver damaged.

#### 4. OFF mode operation

- **Pick up call :**

When receiving a FSK or DTMF call, the Caller ID will display on LCD. The MT-8006B will also add the number to the incoming call list and give it a corresponding order in the list. If the call is from a FSK system, MT-8006B will update the month, date and time setting of system by the information provide by FSK signal. If the call is come from DTMF system, MT-8006B will show the system date and time. LCD will also displays the corresponding order of the receiving call in the incoming call list. If the number is not in the incoming call list, the LCD will indicate it is a new number.

When the ringer is ringing, slide the switch to "Talk" position as common telephone

- **Incoming call list checking and Dialing**

1. Press ▲ or ▼ to enter the incoming calling list.
2. Use the ▲ or ▼ key to view numbers in the Call ID list.
3. To make an auto speed scroll press the ▲ or ▼ key for 3

seconds.

4. Once the incoming number is reached, press LNR key.
5. Set the function to "Talk" mode, and press LNR key, it will automatically dial the number you reached

- **Dialing out list checking and dialing**

1. Press the OUT key to enter outgoing call list.
2. Use the OUT key or ▲ key to view the number in dialing out list.
3. To make an auto speed scroll press the ▲ or ▼ key for 3 seconds.
4. Once the outgoing number is reached, press LNR key.
6. Set the function to "Talk" mode, and press LNR key, it will automatically dial the number you reached.

- **Pre-dial function**

As with a cell phone, user can input the phone number at on-hook status then press LNR to send out the number to make a phone call. It is easy to correct the wrong input in this mode.

## 5. Talk mode operation

- **Incoming call list checking and dialing**

1. Press ▲ or ▼ to enter the incoming calling list.
2. Use the ▲ or ▼ key to view numbers in the Call ID list.
3. To make a auto speed scroll press the ▲ or ▼ key for 3 seconds.
4. Once the incoming number is reached, press LNR key.

- **Dialing out list checking and dialing**

1. Press the OUT key to enter outgoing call list.
2. Use the OUT key or ▲ key to view the number in dialing out list.
3. To make a auto speed scroll press the ▲ or ▼ key for 3 seconds.
4. Once the outgoing number is reached, press LNR key.

## Battery and fuse replacement

If the Data Diver fails to operate properly, or stops working, replace the battery and retest. Do not use rechargeable batteries.

To replace the battery:

1. Disconnect the Data Diver from the line and place on a flat work surface with the battery cover up.
2. Use a Phillips screwdriver to remove the two screws from the battery compartment.
3. Remove the battery cover
4. Remove the old batteries and properly discard.
5. Insert 4pcs of 1.5V AAA batteries into the Data Diver and observe the proper polarity.
6. Place the battery cover back and fasten the two screws securely. Do not over tighten screw. Over tightening will strip the plastic.

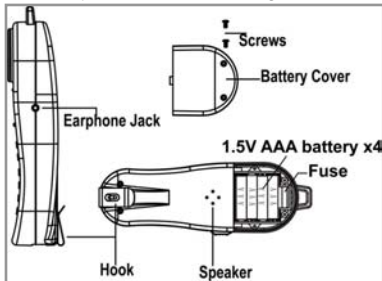

## Fuse replacement

If the Data Diver still stops working after a new battery is replaced, it may be caused by a blown fuse.

To replace the fuse:

1. Use a Phillips screwdriver to remove the two screws from the battery compartment.
2. Remove the battery cover
3. Remove the old fuse
4. Insert a same specification ( $\varnothing 5 \times L 20 \text{mm}$ , 250mA/250V) of fuse
5. Replace the battery cover, then fasten the two screws securely taking care not to over tighten,

 Caution :

Before the battery or fuse replacement, please set it in "OFF" mode position as power off and disconnect the Data Diver from the line. Remove the angled bed of nails, and stay away from any power source or other electric equipment to avoid any electric shock

## MAINTENANCE



### **WARNING:**

- To avoid electric shock, do not perform any servicing other than that contained in the operating instructions unless you are qualified to do so.
- Disconnect clips from any metallic connections before performing any maintenance.

If moisture should get inside the Data Diver, let the Data Diver dry at normal room temperature for 24 hours. **DO NOT HEAT THE DATA DIVER.** Moisture can provide a leakage path that may conduct hazardous voltages to you. **DO NOT USE** the Data Diver if wet.

### Keypad Care

Daily use of your Data Diver results in various liquids, dirt, and other foreign material building up in your keypad. The keypad may be cleaned by using a soft toothbrush with soap and water.

Do not use a petroleum-based or chlorinated cleaning agent as it will harm the keypad. Let the Data Diver dry before using!

### **Data Diver Trouble Shooting:**

1. The MT-8006B Data Diver is a professional telecom tool, especially designed for checking telecom lines. It is not allowed to be used under the power source AC100~125V 50/60Hz or AC200~250V 50/60Hz; otherwise, it may cause the danger of electric shock or product damage.
2. If there is any crosstalk in application, generally it is the interference from the telecom line; please check if the angled bed of nail clips well connected to the telecom line.
3. If any abnormal situation is found while you are using the Prokit's Data Diver, please test the other telecom line in the different area to identify the possible defective situation referring to the trouble shooting list below. (Attention! Please never have the angled bed of nail clips connected to the power source for safety reason.)
4. If the Data Diver still doesn't work after the first step of fix-up, please send back to Prokit's distributor for repairing

 **Caution :**

If the Data Diver connected to a line with voltage over 100V, the fuse will be blown, and it may also caused the IC protection function to start and lock the Data Diver. When it happens, please remove all batteries, and wait for 5-10 minutes until all power is dissipated, then place the batteries back and restart the Data Diver.

<b>Defect Situation</b>	<b>Possible Problem</b>	<b>Solution</b>
Dead, Doesn't work	Blown fuse/IC protection locked	Change new fuse Remove the batteries, wait for 5-10mins and restart the Data Diver
No tone	Angled bed of nails are not well connected	Check if Angled bed of nails are well connected to telecom line
Speakerphone doesn't work	MUTE button was pressed and MUTE LED indicator lights up	Press the MUTE button and check if the MUTE LED is off
Short rings only	Low battery /the angled bed of nails are connected to the power source	Change new battery Confirm if the angled bed of nails connected to the right telecom line
Can not hear the conversation on the Monitor status	The switch did not set to "Mon" position Low battery	Set the switch to "M" position / Change a new battery
Crosstalk	Angled bed of nails are not connected firmly The interference from the telecom line	Check if the Angled bed of nails are well connected
Memory of storing numbers doesn't work	Low battery	Change new battery
Polarity LED doesn't work	Low battery	Change new battery
HI (LED) doesn't work	Low battery	Change new battery
BATT(LED) doesn't work	Low battery	Change new battery

## Specification

ELECTRICAL	
Loop limit	2 K $\Omega$ maximum at 48 Vdc (nominal 20 mA minimum loop current)
DC resistance	
Talk Mode	300 $\Omega$ typical
Monitor impedance	>39k $\Omega$ nominal at 1 KHz
Rotary dial output	
Pulsing rate	10pps+0.8pps
Percent break	60/40% $\pm$ 2%
Inter digit interval	1000 ms typical
Leakage during Break	>130 K $\Omega$
DTMF output	
Tone frequency error	$\pm$ 1.5% maximum
Tone level	-8 $\pm$ 2dBm combined (typical)
High versus low tone	4 dB maximum
Memory dialing	
Memory capacity	12 memories
Digit capacity	16 digits per memory
PBX pause duration	1~3.6 seconds
Power source	4pcs 1.5V AAA batteries (not included)
PHYSICAL ( Hook included )	
Measurement	218.5 x69.5 x 49mm (8.6" x 2.7" x 1.9")
Weight	208g typical







# Pro'sKit<sup>®</sup> MT-8006B 電話查線器

## 安全資訊

### 使用前請先詳讀

表1.描述電話查線器上或本手冊中，所使用的國際電氣符號。

#### 國際電氣符號

	警告：有人身傷害危險。請參閱手冊中的解釋。 小心：有損害或損壞裝置或軟體的危險。請參閱手冊中的解釋。
	警告：有觸電危險。
	注意：須注意操作時的狀態或功能。
	本設備不可連接至公用通信網路，如帶電的電話系統。

#### 警告

- 不得在超過 100V 的帶電電路上使用本產品。
- 不得使用已破損的MT-8006B電話查線器 測試導線。使用以前，請檢查機殼和測試導線是否有破損。
- 在測試電話電路時，將不使用的測試導線和連接器從MT-8006B電話查線器上斷開連接。
- 除非要更換電池，否則不得打開機殼；其中沒有任何用戶可維修的零件。
- 在更換電池以前，請斷開所有測試導線的連接。
- 僅可使用1.5V AAA電池，正確安裝在機殼內以提供電源。
- 如果不遵照指定方式使用本設備，則可能影響產品提供的保護。

以下的IEC標示會被使用在儀器本身或使用手冊中：



請仔細閱讀此部分的使用手冊



對大地接地



CE認證標誌

## MT-8006B電話查線器

本MT-8006B產品包裝所包含的內容如下列所示：

MT-8006B查線器	* 1
耳機麥克風	* 1
標準美式鱷魚夾	* 1
使用手冊	* 1

### 產品特性

MT-8006B是一台用來協助安裝和維修技術人員的攜帶式電話查線器，具有許多功能特性，足以提供安裝類比式電話線路之所需，防誤測保護功能，能防止因誤測而造成儀器本身的損壞，同時提供在100V的電壓下僅燒斷保險絲，但不危害本體的保護功能。

- ◆ LCD: 可顯示撥出號碼、來電號碼、時間及其他資訊
- ◆ 具有來電顯示功能，能迅速檢測出電話線
- ◆ 手持通話/耳機通話功能，查修使用方便
- ◆ 耳機麥克風及標準美式鱷魚夾線
- ◆ 智慧型省電功能，待機狀態下，可6個月不用更換電池（注意：電池未隨機台出貨）
- ◆ 12組雙鍵儲存記憶撥號，每組記憶可達16位數
- ◆ 16個撥出號碼記憶功能，每個號碼可達16位數
- ◆ DTMF/脈衝式撥號，適合各國不同交換機
- ◆ 具最後號碼重撥功能，最多可撥32位數
- ◆ 支援末碼重撥及預撥號功能
- ◆ 具PBX間隔功能，可在撥號時產生大約1秒鐘的間隔，可用於自動總機電話的選項或撥打分機
- ◆ 採用高阻抗監聽電路，監聽中不易產生雜訊輸出
- ◆ 提供極性LED指示，方便檢修時辨識線路極性
- ◆ 電池低電壓LED指示功能，能準確的提示用戶更換電池
- ◆ 智能背光顯示，方便光線較暗的工作環境
- ◆ 本機具有通用RJ-11插座，可直接插入電話線中工作測試。
- ◆ 危險電壓LED指示功能及響鈴警示，能迅速準確顯示當前外線是否誤接。



**警告:**

- ◆ MT-8006B電話查線器並非設計在戶外使用的儀器，我們強烈建議不要在戶外或潮濕的環境下使用MT-8006B電話查線器。
- ◆ 在將MT-8006B接到公眾電信網路前，應先得到相關單位的許可

1. 吊掛環
2. 喇叭出音孔
3. 電話線路極性指示燈
4. 來電與非法電路指示燈
5. 測試模式切換開關
6. LCD 顯示
7. 耳機麥克風插座
8. Mute功能指示燈
9. 電池低電量指示燈
10. Mute功能開關
11. Pulse/Tone切換開關
12. STO(設定/儲存)鍵
13. PSE(PBX間隔)
14. LNR末碼重撥
15. RCL雙鍵記憶重撥鍵
16. ▼下查
17. DEL刪除鍵
18. OUT撥號紀錄查詢
19. ▲上查
20. 標準電話按鈕 0~9, \*, #
21. 麥克風收音孔
22. RJ-11插座

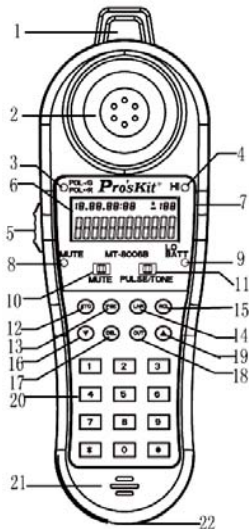

## 電信測試線連接

MT-8006B電話查線器是一款設計帶有6P電話接頭測試器，方便使用者可以快速連接6P電話接頭。連接測試線前，請先移除掛鉤螺絲，將線材安全掛環套上本體固定柱後，再將掛鉤與螺絲鎖回固定位置。

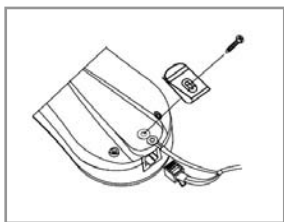

## ⚠注意:

為了延長接頭的使用壽命，在接上6P電信接頭前，請務必先將線材安全掛環連接好後再插接6P電信接頭。

## LCD 顯示說明

- 1、 靜音(MUTE)指示燈
- 2、 年份或電話號碼
- 3、 月份
- 4、 極性指示燈: 亮綠燈代表紅色鱷魚夾所接線路為負極端  
亮紅燈代表紅色鱷魚夾所接線路為正極端
- 5, 6, 7: 日期, 時, 分
- 8、 來電指示
- 9、 號碼次序顯示
- 10、 來電指示和非法線路指示  
來電時鈴聲響起時, HI 燈閃亮。  
如果是非法線路, HI 燈常亮。
- 11、 去電號碼指示
- 12、 電池低電壓指示燈 紅色
- 13、 脈沖/音頻撥號方式切換開關
- 14、 靜音切換開關

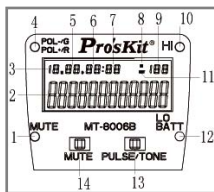

## 按鍵說明

Key	Description	Function	
STO	設置和儲存	在設定模式下按下 STO 鍵可將目前的設定儲存並跳至下個設定項。在撥號模式下按下 STO 鍵可配合其他按鍵, 將目前的電話號碼存入特定位置	
▲/ ▼	方向鍵	按▲/▼鍵可進入來電號碼查詢狀態, 在來電/去電 號碼清單中按▲/▼鍵上查或下查電話號碼	
RCL	重撥鍵	可對雙鍵儲存的電話進行重撥動作	
DEL	刪除鍵	可刪除來電/去電 號碼清單的電話, 或是刪除預撥模式下的最後一位數字	
LNR	末碼重撥鍵	可進行末碼重撥, 或是將預撥模式下輸入的號碼進行撥號	
PSE	間隔鍵	在輸入的電話號碼插入一個 PBX 間隔	
OUT	撥出號清單	進入撥出號碼清單中	
*, #, 0~9	數字鍵	一組標準的電話鍵盤	

## 測試模式切換開關

測試模式切換開關位於 MT-8006B 的左側位置，可切換三種模式：電話模式、待機模式及監聽模式。在電話模式下 MT-8006B 就像一台標準話機，可提供電話線測試功能，在待機模式下可進行內建功能的設定，在監聽模式 MT-8006B 可監聽線路。

## 免持聽筒通訊功能

透過 MT-8006B 所提供的耳機麥克風，使用者可以免持聽筒通話，耳機麥克風的插孔，位於 MT-8006B 右側位置。

## 本機裝置連接

1. 拆除 MT-8006B 背部上方 2 顆螺絲，取下電池蓋，裝入 4 顆 1.5V AAA 電池。
2. 參數設定

MT-8006B 在聽筒掛機狀態下，按下 STO 鍵即可進入設定模式，LCD 會顯示『SET 1 DATE』。此時，用▲或▼鍵可改變設定項目，LCD 同時顯示對應的設定項目。再按 STO 鍵進入該設定項目。在某項設定完成以後，按 STO 鍵進入下一項設定。所有設定均用▲或▼鍵修改該設定的值，設定過程中可用 DEL 鍵退出設定模式。

### ● 設定日期和時間

當 LCD 提示『SET 1 DATE』，按 STO 鍵確認即可進入日期和時間設置項，此時年的顯示會開始閃爍，使用▲或▼鍵調整年份，每次按鍵調整的間隔為 1，完成後再按 STO 鍵進入月的設定，修改月份的方法與年的修改方式相同，再按 STO 鍵可依次修改日、小時和分鐘。月和日的調整間隔也是 1，小時和分鐘的設定可分十位和個位分別設定。時間及日期設置完成後。可按 STO 鍵進入『SET 2 ACODE』，或按 DEL 鍵離開設定模式。當遇到有 FSK 來電信號時，會自動刷新系統時間，DTMF 來電信號對時間，日期的設置無影響。

### ● 設定區碼

當『SET 2 ACODE』顯示在 LCD 上時，按下 STO 鍵可進入區碼設定模式。進入區碼設定後，LCD 顯示“ACODE---- “第一個” - “會開始閃爍，使用▲/▼修改數值，可設定或修改的值為 0 到 9，按 STO 鍵進入第二位數的設定，以此類推。區號設定完成後，按 STO 鍵可進入下一項設定，或按 DEL 鍵離開設定模式。

### ● 設定 PBX 間隔時間設置

當 LCD 顯示“SET 3 FLASH”時，按下 STO 鍵進入間隔時間設置，LCD 會顯示“FLASH 3 110”。3 是預設值，此時的 PBX 間隔秒數為 110ms，用▲/▼鍵修改此數值，共有 110ms/300ms/600ms/1000ms 四種選擇，可充分適用於各種交換機。按 STO 鍵進入下一項設定，或按 DEL 鍵離開設定模式。

## ● 設定 LCD 亮度調整

當『SET 4 LCD』顯示在 LCD 上時，按下 STO 鍵可進入 LCD 亮度調整模式。預設的亮度值是 3，共有 5 種亮度可供選擇，使用▲/▼鍵即可進行切換，切換後的效果會立即顯示在螢幕上，確定後按下 STO 進入下一項設定，或按 DEL 鍵離開設定模式。



**注意:**

“SET 5 ALAR” 並未被使用在本機上，請不要變更此項的設定，請直接按下 STO 鍵跳到“SET 6 IPP” 設定，或按 DEL 鍵離開設定模式。

## ● 撥號模式

當 LCD 顯示 “SET 6 IPP” 時，按下 STO 鍵進入本設定，LCD 會顯示 “IPP OFF”，使用▲/▼在 IPP OFF 及 IPP ON 間進行切換，當選擇 “IPP OFF” 時撥號模式是 DTMF 模式，選擇 “IPP ON” 時撥號模式是脈衝模式。確定後按下 STO，或按 DEL 鍵離開設定模式。

3、將本機美式鱷魚夾夾到電話線端子，或是待測電話線路上。

## ● 通話/ 關機/ 監聽(T / OFF / M) →功能選擇開關：

話機在使用前，要選擇其工作方式，撥動 MT-8006B 上的功能開關（如右圖），選擇在合適的檔位上（話機出廠前均設置為 OFF 關機狀態）

Talk—電話機功能狀態：

在“Talk” 檔位，您可以完整的使用電話機的功能，例如：送/受話，存儲撥號，記憶撥號，未碼重撥，預撥號，來/去電清單撥號…等功能。

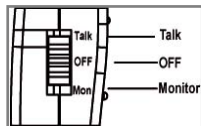

OFF 一線路判斷：

A：本機接檢測線路前，先把功能開關推至“OFF” 檔，如果 HI 燈常亮，代表線路非法，請馬上小心解除連接，以免危及人身安全或造成機子損壞。

B：如果 HI 燈不亮，您可以推至 Talk 或 Mon 檔位操作。

C：如果 HI 燈閃亮並伴有鈴聲響起，代表線路有來電。

D：您可以使用“OFF” 檔來關機。

E：您可以使用“OFF” 檔來測試來電響鈴，鈴聲響起後將功能開關推至“Talk” 檔，可接起電話。

F：建議您使用“OFF” 檔來檢測未知的外線交直流電壓。

## Mon — 監控功能檔位：

您可以使用“Mon”檔來操作監聽功能，功能開關置於“Mon”(監聽狀態)檔，MUTE 燈自動亮紅燈起來，如局線有信號則喇叭發出信號音。

### 注意：

本機於 Talk/ Mon 檔位下，電池需要支援電力給記憶體運作，背光及 Mute 燈也會產生功能，將會造成電力的流失，當機台使用完畢後，請注意將功能開關設定在“OFF”檔位，避免不必要的電力消耗。

### ● 雙音頻/脈沖撥號

本機上設有一個 脈衝撥號/雙音頻撥號 切換開關 (PULSE/TONE)，在不同地區可以使用不同的撥號方式， PULSE/TONE 切換開關，撥到左邊代表脈衝撥號方式，右邊代表雙音頻撥號方式。

### ● STO → 記憶儲存撥號鍵：

您可儲存 12 組電話號碼 (每組最多 16 數字位元) 到數字 (0~9) 及符號 (#, \*)。將功能開關置於“OFF”或“Talk”檔，按電話號碼後+“STO”儲存鍵+所放置的位置 (0~9, #, \*)，則號碼會儲存至所設位置。

### ● RCL → 記憶儲存撥號提取鍵：

您可以使用“RCL”鍵來提取儲存號碼，將功能開關置於“Talk”檔，按“RCL”+所放置的位置 (0~9, #, \*) 則可自動撥出號碼。

### ● LNR → 末碼重撥鍵：

直接按下 LNR 鍵，系統會自動將最後一次撥號的號碼撥出，對未撥通的電話這是一個很方便的功能，末碼重撥功能至多可支援到 32 位數。在查詢來去電紀錄時，亦可按下 LNR 鍵，撥出目前顯示在 LCD 上的號碼。將功能開關置於“Talk”檔 (電話接通狀態)，按“LNR”鍵可自動撥出最後一次撥出號碼。

### ● PSE → 暫停功能鍵：

為了滿足小型交換機 (PBX) 的需要，您可以使用“PSE”鍵來插入暫停功能 (暫停時間約為 4 秒)，例如：您要撥打電話號碼 1234567 經總機系統再轉分機 000，功能開關於“T”檔 (電話接通狀態) 撥 1234567 後+“PSE”鍵再按 000 則直接撥出號碼並進入分機號。

### ● DEL → 刪除鍵：

- 在“OFF”檔位參數設定模式下，按下 DEL 鍵可直接跳出設定模式
- 在“OFF”檔位輸入電話號碼時，按下 DEL 鍵可刪除最後一個數字或符號
- 在來/去電清單查詢時，按下 DEL 鍵可刪除目前顯示的號碼

- **MUTE →靜音開關鍵：**

您可以使用“MUTE”鍵暫時關閉送話，使用通話過程中，將 MUTE 開關撥到左邊，“MUTE”燈會亮起，可暫時關閉送話，將 MUTE 開關撥到右邊，“MUTE”燈熄滅，可回復送話。

- **POL-/G；POL+/R →線路極性判別燈：**

當您在查修電話線而無法判別兩根線的正、負極性，可使用本機的極性判別燈號，確認所夾的線路是否極性正確。

例如：將本機的電信專用夾頭分別夾到電話線上，將功能開關置於“Talk”檔，面板左上邊 POL 燈亮紅色，表示所夾線路極性正確，紅色鱷魚夾所夾的線為正極；反之當所夾線路極性錯誤時，面板左上邊 POL 燈亮綠色，表示紅色鱷魚夾所夾的線為負極，需重新換邊夾上線路再測試。

- **LO BATT →電池低電壓指示燈：**

當您發現面板上“LO BATT”燈亮起時，代表電池低於可工作電壓，此時請盡快更換電池，以免誤判測試數據或儲存資料遺失。

 **注意：**

本機儲存記憶功能只能維持 15 秒鐘，更換電池時，請注意電池極性不可裝反，若記憶消失，請依說明書之各項操作重新輸入。

- **HI →外線線路非法 LED 指示：**

功能開關撥到“OFF”檔，將鱷魚夾夾到兩外線上，HI (LED) 亮紅色，表示所測電壓高於 DC 70V，切勿將 MT-8006B 使用於此條線路上，避免損壞機台。

#### 4、OFF 檔位 掛機狀態的操作

- **接聽來電：**

當接收到一通 FSK 或 DTMF 來電時，話機會自動偵測並顯示來電號碼，同時顯示來電的日期、時間，並記錄這是第幾通來電。若是 FSK 來電，來電顯示信號同時會自動更新系統的月、日以及時間的設定，而年的設定則不變。當來電是 DTMF 信號時，系統會將目前的系統日期及時間賦予該來電號碼，LCD 同時顯示來電序號。系統同時會將此號碼存入到來電清單中的第一項，其他已存在的號碼則順移一個位置。重複的號碼只存最新的一次來電紀錄。

鈴聲響起後，將功能開關推至“Talk”檔，即可接起電話。

- **來電清單及撥號：**



1. 按下▲或▼鍵進入來電清單查詢功能。
2. 使用▲或▼鍵查詢所需要的號碼。
3. 按下▲ 或▼鍵超過 3 秒鐘，可進行清單自動跳號查詢功能。
4. 當想要查詢的號碼出現在 LCD 上時，按下 LNR 鍵撥出號碼。
5. 將功能開關推至“Talk”檔，按下 LNR 鍵，即可撥出來電號碼。

● **去電清單及撥號：**

1. 按下 OUT 鍵進入去電清單查詢功能。
2. 使用 OUT 鍵及▲鍵查詢所需要的號碼。
3. 按下▲ 或▼鍵超過 3 秒鐘，可進行清單自動跳號查詢功能。
4. 當想要查詢的號碼出現在 LCD 上時，按下 LNR 鍵撥出號碼。
5. 將功能開關推至“Talk”檔，按下 LNR 鍵，即可撥出去電號碼。

● **預撥號功能：**

在掛機狀態下，通過各數字鍵輸入要撥出的號碼。若有輸入錯誤，可用 DEL 鍵修改，全部輸入完成以後，按下 LNR 鍵撥出號碼。再將功能開關推至“Talk”檔，按下 LNR 鍵，即可撥出預撥號碼。

5、Talk 檔位 通話狀態的操作

● **來電清單及撥號：**

1. 按下▲或▼鍵進入來電清單查詢功能。
2. 使用▲或▼鍵查詢所需要的號碼。
3. 按下▲ 或▼鍵超過 3 秒鐘，可進行清單自動跳號查詢功能。
4. 當想要查詢的號碼出現在 LCD 上時，按下 LNR 鍵撥出號碼。

● **去電清單及撥號：**

1. 按下 OUT 鍵進入去電清單查詢功能。
2. 使用 OUT 鍵及▲鍵查詢所需要的號碼。
3. 按下▲ 或▼鍵超過 3 秒鐘，可進行清單自動跳號查詢功能。
4. 當想要查詢的號碼出現在 LCD 上時，按下 LNR 鍵撥出號碼。

**日常保養**

在日常使用的過程中，會使 MT-8006B 接觸到液體、灰塵或其他的物質，而導致 MT-8006B 髒污，或附著在鍵盤上或縫隙間，請用軟性的刷子沾上少許的中性肥皂或中性清潔劑來清潔 MT-8006B，或些許沾溼的布來清潔 MT-8006B，並在清潔後用柔軟及乾淨的布擦乾 MT-8006B。

請勿使用油性或是腐蝕性的清潔劑來清潔 MT-8006B，這可能會損害到 MT-8006B 的本體或鍵盤。切記在使用之前要確認 MT-8006B 是乾燥的。

## 電池、保險管更換說明與圖解：

1. 當您的話機 LO BATT 亮燈或部分功能失效的現象，可能是電池電量不足，請更換新電池。用十字螺絲起子取下電池蓋的兩個螺絲，拿起電池蓋，安裝電池，要注意電池的極性，不要裝錯。（請選用特性較佳之高性能電池，確保監聽音量）

2. 當您的話機有死機、不通電的現象時，代表您的保險管可能已被燒毀，請檢查保險管。用十字螺絲起子取下電池蓋的兩個螺絲，接著取出保險管，並更換相同規格的保險管（ $\phi 5 \times L20\text{mm } 250\text{mA}/250\text{V}$ ）。

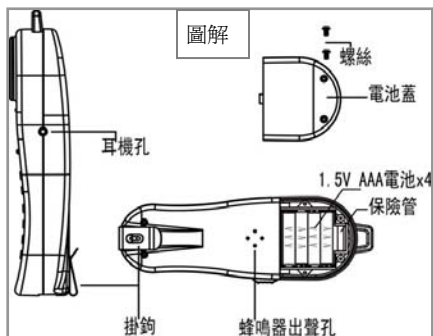

### ⚠注意：

在更換電池或保險管時，話機必須處於非工作狀態下，將電信專用夾線取下，並遠離電源等其他電器設備，以免發生觸電危險

## 簡易故障排除方法

- 1、本話機屬於專業通信維修工具，適合通信查線使用，嚴禁在任何具有 AC100~125V 50/60Hz 或 AC200~250V 50/60Hz 的交流電源下作業，以免產生觸電危險或損壞話機。
- 2、本話機操作時，如有雜音現象，一般為電信線路中含有雜訊所致。檢查鱷魚夾所夾的線路是否為電訊信號線，鱷魚夾是否接觸良好。
- 3、當您發現有不正常的現象時，請先使用不同局域的電信局線重新測試，並判斷故障原因，請參考下列（簡易故障排除方法）。如果還是無法排除故障，請送回原來購買的 **Pro'sKit** 經銷商處維修。

### ⚠注意：

本話機如果誤觸高於 100V 以上交流電源，除了可能燒毀保險管以外，可能造成 IC 啟動保護鎖機，而無法進行正常作業，此時只需將電池全部取下，靜置 5~10 分鐘，等待話機電力全部消散後，重新裝回電池，即可回復原始設定，恢復正常使用。

## 簡易故障排除方法

故障現象	可能原因	解決方法
死機，不通電	保險管燒斷 / IC 保護鎖機	更換同型號保險管 / 取下電池，靜置 5~10 分鐘，再重新開機
電話機測試無聲音	線路連接不正確或不牢靠	檢查電信專用夾與被測電話局線是否接好（必須為電信電話線）
麥克風不能發話	已開啓閉音功能（MUTE）	關閉閉音功能（MUTE）
斷鈴	1. 電池電量不足 2. 夾到 AC 電源上	1. 更換同型號電池 2. 確定線路是否為電信訊號線
監控無聲音	1. 監控功能或擴音功能沒有開啓 2. 電池電量不足	1. 開啓監控功能及擴音功能 2. 更換同型號電池
雜音	1. 線路連接不牢靠 2. 線路本身電路雜音	1. 檢查電信專用夾是否與電信局線接觸良好
記憶失效	電池沒電	更換同型號新電池
極性判別 POL + / - LED 燈不亮	電池沒電	更換同型號新電池
VDC LO/HI(LED)燈不亮	電池沒電	更換同型號新電池
LO BATT(LED)燈不亮	電池沒電	更換同型號新電池

當 MT-8006B 可能有濕氣侵入機殼時，請將 MT-8006B 放置於一般環境下的乾燥位置 至少 24 小時，**絕對不要以加熱方式去除溼氣。**

濕氣會提供電氣導通的路徑，可能會導致使用者觸電，絕對不要在 MT-8006B 潮濕的時候使用它

### ⚠️ 注意:

- 請不要用本手冊上未提及的方式使用 MT-8006B 電話查線器，以免造成任何電氣衝擊
- 進行任何保養動作前，請先將測試線或鱷魚夾，從待測物體上移除

## 產品規格

電氣特性	
環路阻抗	最大 2 K $\Omega$ /48 VDC (典型環路電流 20mA)
直流阻抗	
通話阻抗	300 $\Omega$
監聽阻抗	>39k $\Omega$ , 1 KHz
脈衝式撥號輸出	
脈衝率	10pps+0.8pps
間隙率	60/40% $\pm$ 2%
信號間隔	1000 ms typical
漏阻抗	>130 K $\Omega$
音頻式撥號輸出	
音頻誤差率	$\pm$ 1.5% 最大值
音頻音量	-8 $\pm$ 2dBm combined (typical)
音頻訊號音量差	4dB 最大值
記憶撥號	
記憶容量	12 組
數字容量	16 位數字
PBX 中斷時間	1~3.6 秒
工作電源	4 顆 1.5V AAA 電池 (不附電池)
外殼與尺寸 (含金屬掛鉤)	
長 x 寬 x 高	218.5 x 69.5 x 49 mm / 8.60 x 2.7 x 4.9 inch
重量	208 g (不含電池及配件)

**PROKIT'S INDUSTRIES CO., LTD.**